

LiFePO4 Rack Battery

iPower Rack Series User Manual

Version:V1.0

CONTENTS

Information About The Manual

1. SAFETY PRECAUTIONS

2. PRODUCT OVERVIEW

2.1 Brief introduction.....	03
2.2 Features	03
2.3 Specifications Performance	04
2.3.1 Battery Parameters	04
2.3.2 Interface Definition	05
2.3.3 Battery Management System.....	07
2.4 Label Description	08
2.4.1 Box Warning	08
2.4.2 Battery Nameplate	09

3. INSTALLATION

3.1 Checking Before Installation	10
3.1.1 Accessories Checking.....	10
3.1.2 Tools Needed.....	11
3.2 Safety Requirements.....	11
3.3 Electronic Checking	12
3.4 Environment Requirements	12
3.5 Space Requirements	13
3.6 Wall Mounted Installation	14
3.6.1 Single Used	14
3.6.2 Battery Parallel Used.....	14

4. OPERATION

4.1 Electronic Connection.....	15
4.1.1 Cabling Introduction	15
4.1.2 Communication Port Definition	15
4.1.3 System Connection Diagram	16
4.1.4 Battery Single Used.....	17
4.1.5 Battery Parallel Used.....	18
4.2 Function And Commission	19
4.2.1 LCD Display Description.....	19
4.2.2 Indicator Description.....	22
4.2.3 Buzzer Operation	23
4.2.4 RST Key Description	23
4.2.5 Sleep&Activation Operation.....	24
4.2.6 Battery Monitoring.....	24

5. CARE AND MAINTENANCE

5.1 Care	29
5.2 Maintenance.....	29

6. FAQ AND TROUBLESHOOTING

6.1 FAQ	30
6.2 Troubleshooting.....	31

Preface

This users manual describes the Powerwall battery in terms of basic specification, installation, electrical connections, functions, maintenance, and troubleshooting. Please read this document through before installing and operating it.





NOTE

Depending on different contract, product version and market region, details may appear slightly different.

Symbol Conventions

Please pay particular attention to the information provided by the following symbol.

01

Symbol	Description
	Indicates a hazardous situation which, if not avoided, could result in injury or death
	Indicates a hazardous situation which, if not avoided, could result in minor injury or damage to the equipment
	Indicates potentially hazardous situations which, if not avoided, could cause damage to the battery, loss of data, or impairment of performance. NOTICE is used to address practices not related to personal injury
	Indicates important supplements that leads to the best result, but is not safety or damage related

1. SAFETY INSTRUCTIONS

Reminded

⚠ WARNING

Do not expose cable outside.

⚠ CAUTION

- Do not connect battery with PV solar wiring directly.
- Do not use cleaning solvents to clean the battery.

⚠ NOTICE

- If the battery is stored for long time , it is required to charge them every six months, and the SOC should be no less than 60%.
- Battery needs to be recharged within 12 hours, after fully discharged.

● NOTE

Please contact the supplier within 24 hours if there is something abnormal.

Before Connecting

⚠ WARNING

It is prohibited to connect the battery and AC power directly.

⚠ CAUTION

- The embedded BMS in the battery is designed for 48VDC, please DO NOT connect battery in series.
- Before installation, be sure to cut off the grid power and make sure the battery is in the turned-off mode.
- Wiring must be correct, do not mistake the positive and negative cables, and ensure no short circuit with the external device.

⚠ NOTICE

- It is prohibited to connect the battery with different type of battery.
- Keep the battery away from water and fire.

● NOTE

- After unpacking, please check product and packing list first, if product is damaged or lack of parts, please contact with the local retailer.
- Please ensure the electrical parameters of battery system are compatible to related equipment.

In Using

⚠ WARNING

In case of fire, only dry powder fire extinguisher can be used, liquid fire extinguishers are prohibited.

⚠ CAUTION

If the battery system needs to be moved or repaired, the power must be cut off and the battery is completely turned off.

2.PRODUCT OVERVIEW

2.1 Brief Introduction

iPower series LiFePO4 battery is specially tailored for energy storage system, it offers a greater efficiency, higher reliability, intelligent battery management system, intelligent battery monitoring system, long lifespan to your solar energy backup.

iPower series LiFePO4 battery is ideal for off-grid and hybrid applications, offering a solution that's built for the long run and has the ability to be deployed and used in a variety of scenarios, for instance, residential, farm, factory, data room, holiday hotel, etc.

2.2 Features

- ▶ Lithium iron phosphate chemical material, which endows battery safer performance, longer service life and superior energy density.
- ▶ The fully intelligent battery management system (BMS) protects battery pack and cells from over-current, under-voltage, over-voltage, impulse current, short circuit, and severe temperature damage, which further increases the safety performance of battery.
- ▶ The intelligent monitoring system allows you to monitor and download real time data of your battery in on your computer.
- ▶ The cell balancing function greatly extends the service life of the battery pack.
- ▶ Without any memory effect, you can deep charge and release your battery.
- ▶ With tiny self-discharge consumption, the battery will automatically enter low power consumption mode if you don't use it for more than 24 hours.
- ▶ Environmentally friendly. No heavy metals and no harmful substances, battery meets ROHS requirements.
- ▶ Scalability. Multiple battery packs can be used in parallel, which is suitable for any scenario that requires greater power backup.
- ▶ Maintenance-free. Battery requires no active maintenance, a one-time purchase guarantees longevity (assuming you're using a properly fitted battery and following usage guidelines).
- ▶ Comply with IEC62619, CE, ROHS, UN38.3 requirements.

2.3. Specifications Performance

2.3.1 Battery Parameters

Table 2-1

Series	iPower Rack
Battery Type	LiFePO4
Model	YL-S48100
Nominal Voltage[V]	48
Nominal Capacity[Ah]	100
Nominal Energy[kWh]	4.8
Max. output Power[kW]	4.8
Net Weight[Kg]	45
Dimension [mm]W*D*H	442*450*178
Working Voltage[V]	40~54
Operating Temperature Charging[°C]	0~55
Operating Temperature Discharging[°C]	-20~60
Max. Charge Current[A]	100
Max. Discharge Current[A]	100
Recommend Charge Current[A]	20
Charge Mode	CC-CV
Communication	CAN/RS485/RS232/Dry Contact
IP Level	IP30
Temperature & Period Storage[°C]	Less than 6 Month@-10°C~35°C
	Less than 3 Month@-10°C~45°C
	Less than 1 Month@-20°C~45°C

2.3.2.Interface Definition

a) The Battery appearance is shown in below figure as a reference

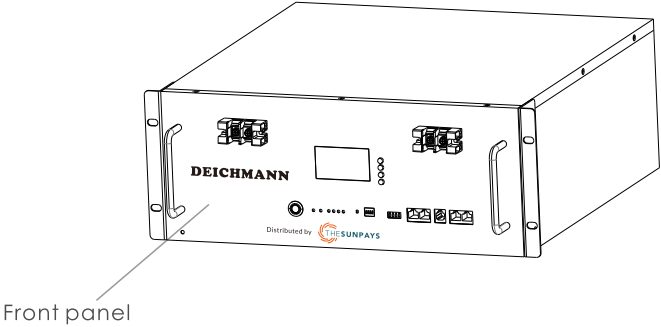

b) The Battery dimension is shown in below figure as a reference

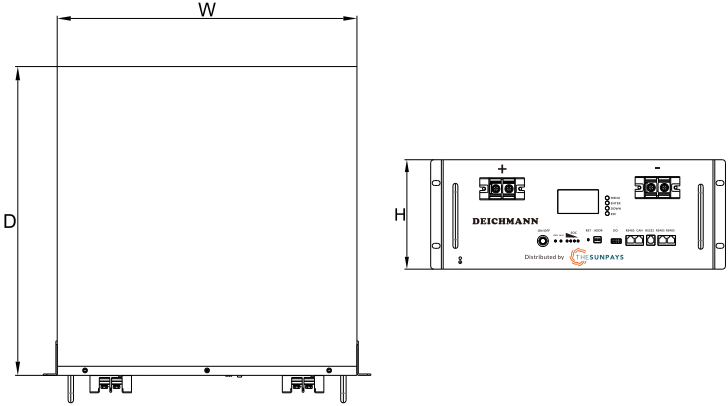

05

iPower Rack LiFePO4 Battery	
Model	YL-S48100
Energy[kWh]	4.8
Width[mm]	442
Height[mm]	178
Depth[mm]	450

c) Bottom area and all the interfaces is shown in below figure as reference

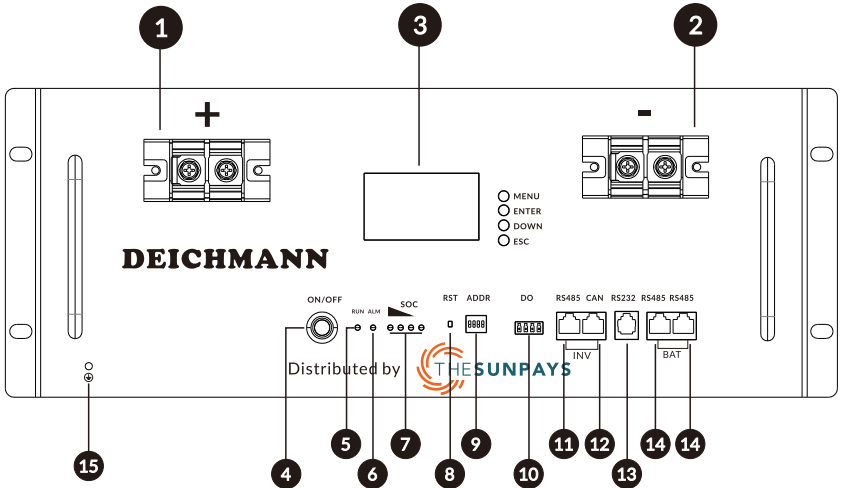

No.	Items	Description
①	+ Power Terminal	Power cable terminals: there are two pair of terminals with same function, one connect to equipment, the other one paralleling to other battery module for capacity expanding,for each single module, each terminal can achieve charging and discharging function
②	- Power Terminal	
③	LCD Screen	Display the battery data
④	Power Switch	To turn ON/OFF the whole battery
⑤	Working indicator light	Display state information
⑥	ALM alarm indicator light	Red-trouble-light on
⑦	Capacity volume indicator	Display the battery's capacity
⑧	Reset Key	Sleep /Activation /Reset
⑨	ADS Dialer	4 ADD switches, to definite different address code for each battery module when multiple modules are cascaded, up to 15 addresses
⑩	Dry Contact Terminal	1/2 Normally open, closed during fault protection; 3/4 Normally open, closed when a low battery alarm

No.	Items	Description
⑪	RS485	RJ45 Port, used to connect to the inverter's RS485 port
⑫	CAN	RJ45 Port, used to connect to the inverter's CAN port
⑬	RS232	RJ11 Port, used battery condition monitoring or manufacturer to debug or service
⑭	RS485	RJ45 Port, Used communication in parallel
⑮	Grounding Point	Safety

2.3.3 Battery Management System

Function	
Alarm	Protection
Cell Over-charge Voltage	Cell Over-charge Voltage
Cell Over-discharge Voltage	Cell Over-discharge Voltage
Pack Over-charge Voltage	Pack Over-charge Voltage
Pack Over-discharge Voltage	Pack Over-discharge Voltage
Over-current Charge	Over-current Discharge
Over-current Discharge	Over-current Discharge
Mos Over Temperature	Mos Over Temperature
Cell Charge Low Temperature	Cell Charge Low Temperature
Cell Charge Over Temperature	Cell Charge Over Temperature
Cell Discharge Low Temperature	Cell Discharge Low Temperature
Cell Discharge Over Temperature	Cell Discharge Over Temperature
Environment Low Temperature	Environment Low Temperature
Environment Over Temperature	Environment Over Temperature
	Short Circuit Protection
	Fault Protection

2.4 Label Description

2.4.1 Box Warning Label

 **WARNING**

Please read all safety precautions and users manuals before use or operation.

[Prevention]

- Do not open, disassemble or destroy the battery.
- Do not short circuit terminals, over charge or forced over-discharge the battery.
- Do not crush or puncture the battery, or immerse in liquids.
- Avoid to use battery of different sizes, types or chemical properties.
- Avoid to force impact the battery.







[Response]
In case of fire or leakage: Fire fighting/disposal shall be carried out in strict accordance with the relevant guidelines of SDS.







[Disposal]
Dispose of batteries under relevant National and Local regulations.

[Parallel Using]

- New and old batteries are forbidden to be connected in parallel.
- Different brands of batteries are forbidden to be connected in parallel.
- Be sure the difference between parallel connected battery packs cannot be greater than the following values.

Item	Difference Between Batteries
SOC	≤5%
Voltage	≤0.3V

Symbol	Symbol Name	Symbol Description
	Warning	Be careful with your actions and be aware of the dangers
	Anti-electric Shock Warning	Battery voltage is higher than safe voltage, direct contact with electric shock hazard
	Beware Of Fire	Serious improper operation will cause battery failure and cause fire
	View Manual	Read the user manual before using
	No Burning	Strictly prohibit all sources of fire
	Recyclable	After the battery life is terminated, the battery can continue to be used after it recycled by the professional recycling organization and do not discard it at will
	Don't Throw Into The Trash Can	The scrapped battery cannot be put into the garbage can and must be professionally recycled

2.4.2 Battery Nameplate

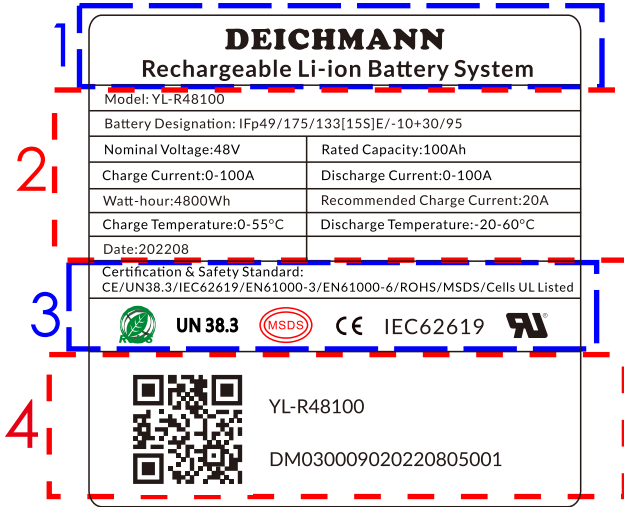

No.	Description
1	Trademark and product type
2	Important technical parameters of the product
3	Identification of the certification system that the product complies with
4	Product traceability QR code

Symbol	Symbol Name	Symbol Description
	ROHS	The battery product meets Restriction of Hazardous Substances
UN 38.3	UN38.3	The battery product meets United Nations Manual of Tests and Standards for Transport of Dangerous Goods
	MSDS	The battery product meets Material Safety Data Sheet
CE	CE	The battery product meets European directive requirements
IEC62619	IEC62619	The battery product meets IEC requirements



YL-R48100

DM030009020220805001

NOTE

Each product has a unique barcode.

3. INSTALLATION

3.1 Checking Before Installation

3.1.1 Accessories Checking

- ▶ When the equipment arrives at the installation site, loading and unloading should be carried out according to the rules and regulations, so as to prevent from being exposed to sun and rain.
- ▶ Before unpacking, the total number of packages shall be indicated according to the shipping list attached to each package, and the case shall be checked for good condition.
- ▶ In the process of unpacking, handle with care and protect the surface coating of the object.
- ▶ Open the package, the installation personnel should read the technical documents, verify the list, according to the configuration table and packing list, ensure objects are complete and intact, if the internal packing is damaged, should be examined and recorded in detail.

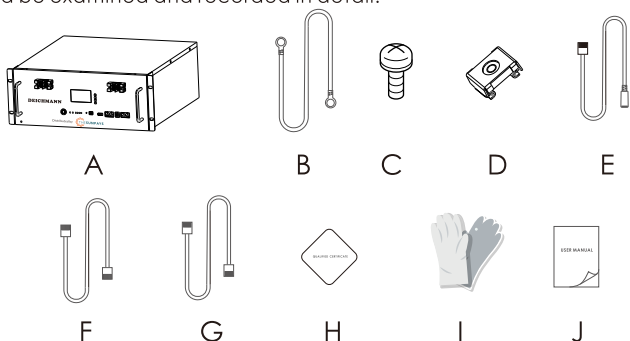

No.	Items	Qty	Remark
A	Battery	1	iPower Rack YL-S48100
B	Power cable	2	One positive and negative pole each, one end connected to the battery, one end to the inverter; Length 1.5m
C	Screw	4	M6*20
D	Cage nut	4	M6
E	RS232 Communication cable	1	USB connector to RJ11 connector; Length 1.5m
F	Communication cable	1	RJ45 connectors, Parallel battery communication, Length 1m
G	Communication cable	1	RJ45 connectors, connected battery and inverter, Length 2m
H	Qualified certificate	1	QC PASS
I	Insulated gloves	1	Protect hands
J	USER MANUAL	1	For users to refer to, install, and train

NOTE

The accessories are stipulated by the purchase contract. All or part of the accessories, services and features described in this document may not be within the purchase scope or the usage scope.

3. 1.2 Tools Needed



Pliers



Screw driver



Wrench



Torque wrench

3.2 Safety Requirement

This system can only be installed by personnel who have been trained in the power supply system and have sufficient knowledge of the power system;The safety regulations and local safety regulations listed below should always be followed during the installation.

- ▶ All circuits connected to this power system with an external voltage of less than 24V/48V must meet the SELV requirements defined in the IEC60950 standard.
- ▶ If operating within the power system cabinet, make sure the power system is not charged. Battery devices should also be switched off.
- ▶ Installation space and load bearing. Make sure that there are sufficient fixed components to install the battery system, and to ensure that the battery mounting bracket or the cabinet be strong enough to bear the weight.
- ▶ Distribution cable wiring should be reasonable and has the protective measures to avoid touching these cables while operating power equipment.
- ▶ When installing the battery system, must wear the protective items below:



Insulated gloves



Safety goggles



Safety shoes



Mask

- ▶ Cable specifications. To ensure that the use of the connection of the power supply line can meet the maximum current requirements of equipment operation.
- ▶ The installation site should be at least two or more peoples to operate.
- ▶ The whole installation process should wear anti-static wristband.
- ▶ Wiring layout. Ensure that the wiring reasonable, orderly; and consider the moisture-proof,corrosion prevention.
- ▶ Firefighting equipment should be provided near the equipment, such as portable dry powder fire extinguisher.

- ▶ Automatic fire fighting system shall be provided for the case where necessary.
- ▶ No flammable, explosive and other dangerous articles are placed beside the battery.

3.3 Electronic Checking

- ▶ Check that the equipments connected with batteries are right and in good conditions.
- ▶ Check the DC interface position of the equipment, check and confirm the output voltage is in the range shown in table 2-1.
- ▶ Check the maximal working current of devices backed by the battery, make sure that the current is less than the maximum discharge current of the products shown in table 2-1.

3.4 Environmental Requirements

- ▶ Working temperature: $-20^{\circ}\text{C} \sim +60^{\circ}\text{C}$.
Charging temperature range is $0^{\circ}\text{C} \sim +55^{\circ}\text{C}$;
Discharging temperature range is $-20^{\circ}\text{C} \sim +60^{\circ}\text{C}$
- ▶ Storage temperature: $-10^{\circ}\text{C} \sim +45^{\circ}\text{C}$.
- ▶ Relative humidity: 5% ~ 85%RH.
- ▶ Elevation: no more than 4000m.
- ▶ Operating environment: no conductive dust and corrosive gas sites.
- ▶ Installation location should be away from the sea to avoid brine and high humidity environment.
- ▶ The ground is flat and level.
- ▶ There is no flammable explosive near to the installation places.
- ▶ The optimal ambient temperature is $15^{\circ}\text{C} \sim 35^{\circ}\text{C}$.
- ▶ Keep away from dust and messy zones.
- ▶ Keep away from area children can reach.

NOTICE

If the ambient temperature is out of the operating range, it will trigger the battery temperature protection function to turn off working. The optimal temperature range for the battery pack to operate is 15°C to 35°C . Frequent exposure to harsh temperatures may deteriorate the performance and life of the battery pack.

3.5 Rack Mounted Installation

3.5.1 Install The Mounting lugs(if necessary)

Equipment packaging with the chassis mounting lugs, before the installation of equipment, fix the mounting lugs on both sides of the battery box,ensure that the installation strong.

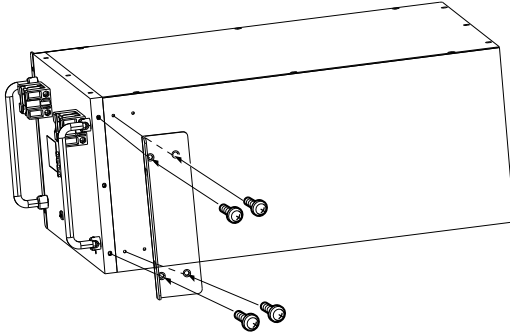

3.5.2 Battery Installation

Battery module preference mounted in the rack 19 inch (or cabinet),when installed, portable handle arranged in parallel on the frame (or cabinet) supporting plate, push rack (or cabinet), ensure the mounting lugs and frame (or cabinet) edge fixing hole tightly, and then using a screwdriver with screw for fixation screwed into the rack to the mounting holes, to ensure that the battery pack mounted solid.

13

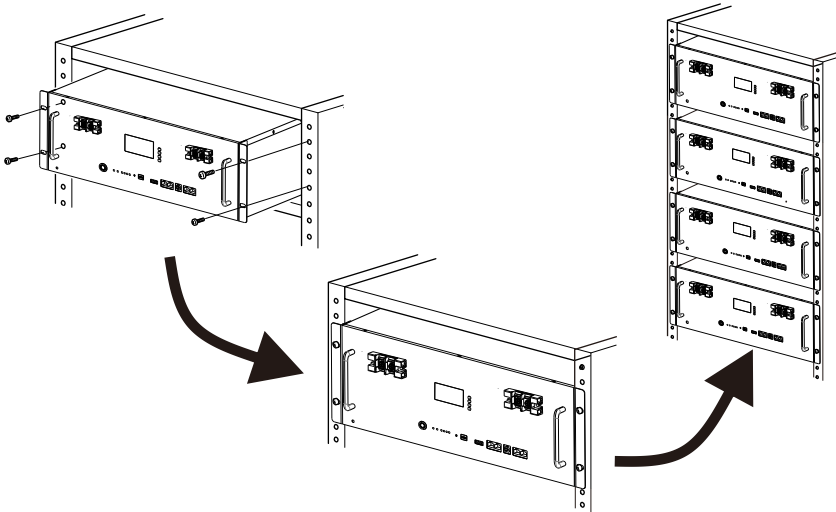

WARNING

Please install the battery out of the reach of children.

4. OPERATION

4.1 Electronic Connection

4.1.1 Cabling Introduction

The battery output terminal are the OT terminal ;Power cable section 25mm².

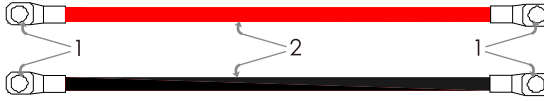

No.	Items	Remark
1	OT Terminal	SC25-8
2	Cable	Cross-section:25mm ²

4.1.2 Communication Port Definition

RJ45 Communication Port Definition

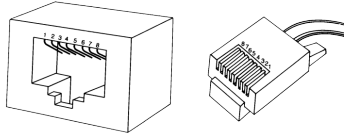

Pin	RS485-----8P8C RJ45 Port	CAN-----8P8C RJ45 Port
	Function Description	Function Description
1	RS485-B	NC
2	RS485-A	NC
3	GND	NC
4	NC	CANL
5	NC	CANH
6	GND	NC
7	RS485-A	GND
8	RS485-B	NC

NOTE

Different inverters have different pin definitions, please pay attention to the compatibility with batteries.

RJ11 Communication Port Definition

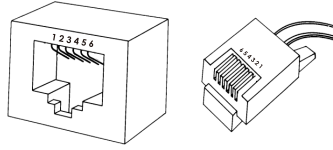



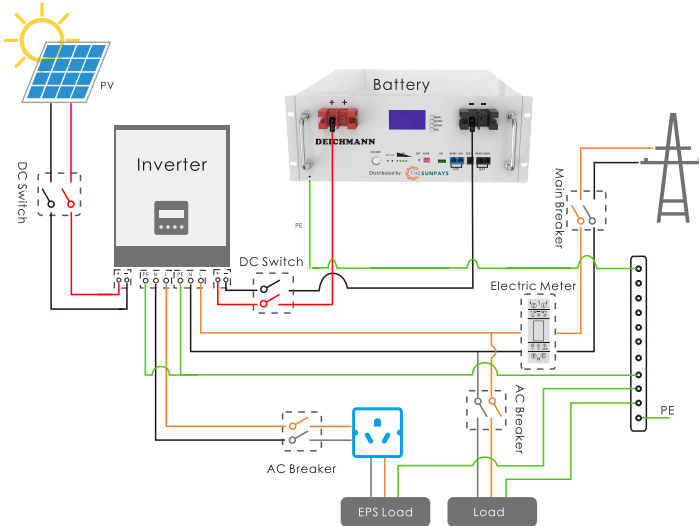

RS232-----6P6C RJ11 Port	
Pin	Function Description
1	NC
2	NC
3	BMS Transmit, PC Receive
4	PC Transmit, BMS Receive
5	GND
6	NC

4. 1.3 System Connection Diagram





15

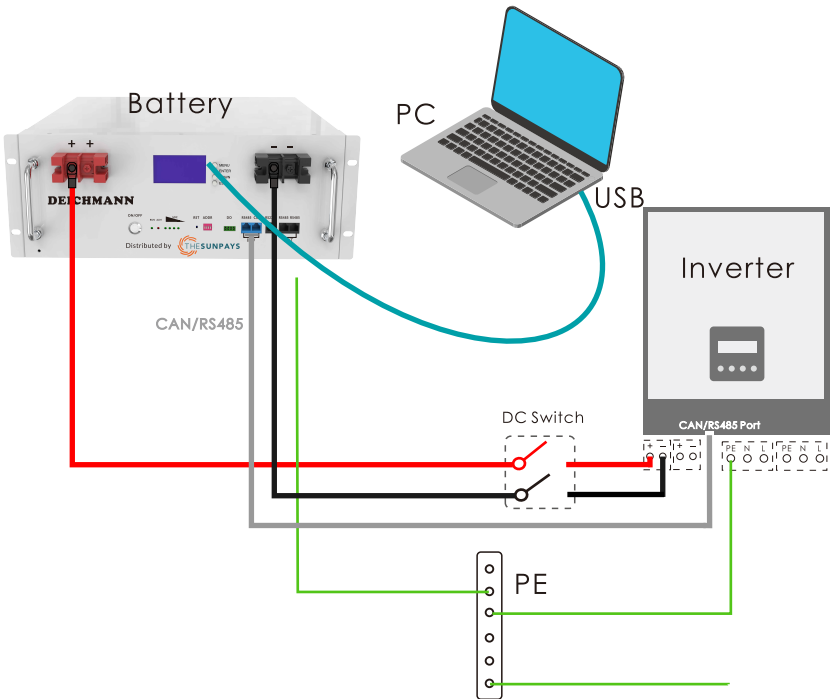

Cable Color	Description	Cable Color	Description
	Positive power cable		Live wire
	Negative power cable		Neutral wire
	Ground wire		

4. 1.4 Battery Single Used



Cable Color	Description	Cable Color	Description
	Positive Power Cable		Ground Wire
	Negative Power Cable		The Communication Line connecting The Battery And The PC
	Communication Line Connecting Battery And Inverter		

NOTICE

Before connection, the positive and negative pole of the inverter input interface and the battery output interface should be confirmed. The red power line is connected to the positive pole and the black power line is connected to the negative pole.





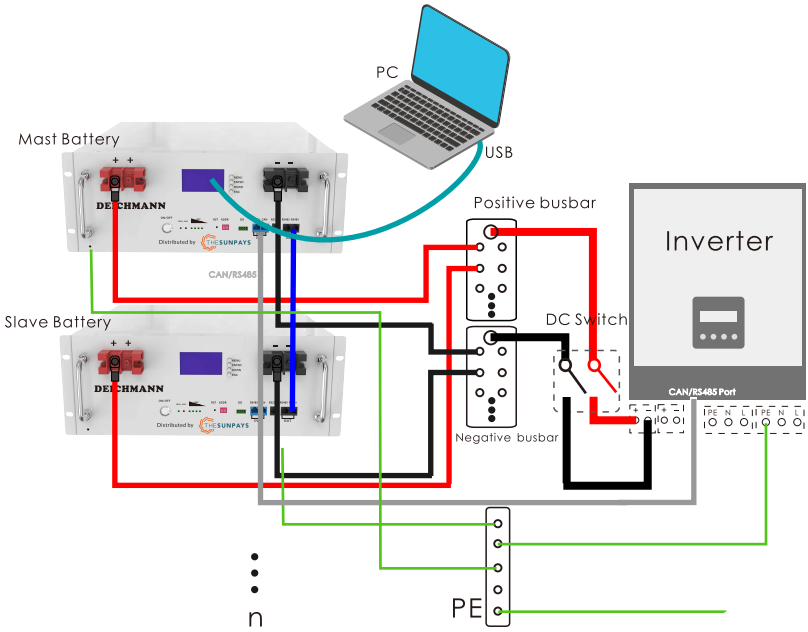

NOTE

Only when you need to monitoring the battery status, connecting battery with PC is necessary.

4. 1.5 Battery Parallel Used



17

Cable Color	Description	Cable Color	Description
	Positive Power Cable		Ground Wire
	Negative Power Cable		The Communication Line Connecting The Battery And The PC
	Communication Line Connecting Battery And Inverter		Communication Line Connecting Battery And Battery In Parallel

NOTE

While in parallel communication, the dial-up addresses of battery module are 1,2,3,4.....14,15, where 1 stands for the main engine, the data of other batteries are uploaded to the main engine conducts unified uploading. The host computer with dial-up code of 1 to connect with upper computer.



4. 1.6 Multi-units parallel use instructions

The batteries are connected in parallel should according the requirements in the manual.

- Grounding cable. The grounding cable end with screw press-fit fixation in the chassis rear grounding hole, the other end is connected to the frame (or cabinet) grounding copper bar, To ensure the stable connection.
- Install Parallel power cables and Communication parallel cable between multi batteries.
- Connect the positive and negative Power cable of the battery to the inverter.
- Connect the Communication cable of battery to the inverter.
- Set the DIP switch mode of the host and slave battery. (Set the DIP switch mode first, then turn on the batteries, this point is very important!)
- Turn on the power switch of each battery.

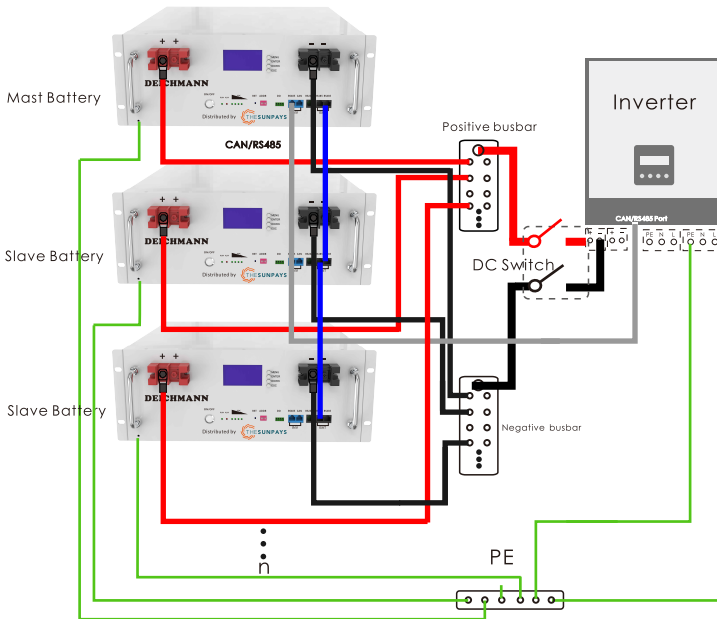

NOTICE

During the normal operation of the parallel battery system, it is forbidden to arbitrarily turn off one or more of the batteries. Or prohibit the operation of turning off and then turning on individual batteries.

NOTICE

Multi-batteries must follow the "common advance and retreat" principle, that is, after turning off one of the batteries, all other batteries in the system need to be turned off also, which is regarded as "common retreat" operation. After turning on one of the batteries, all other batteries in the system need to be turned on also, which is regarded as "common advance", this operation is very important.

4.2 Function and Commission

4.2.1 LCD Display Description

Refer to below flow chart which shows the information option interfaces and interconnection. Operator can search target information by following below directions.



Each item starts with “»” or “--”, where “»” displays the current cursor position, press the “DOWN” key to move the cursor position; end with the item “»”, the content of the item is not displayed, press“ENTER” You can go to the corresponding page.

The LCD screen will automatically go off after one minute of inactivity, and will automatically light up after pressing any key.

a)Enter the display menu interface.

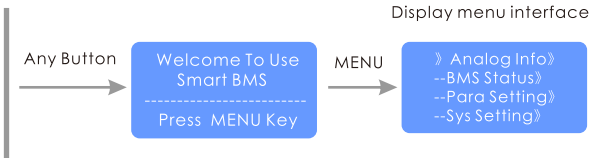

b) Steps for viewing product total voltage and current information.

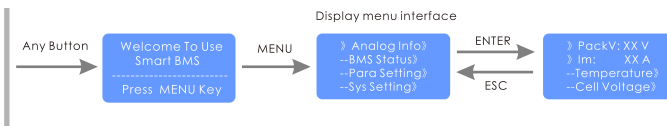

No.	Items	Description
1	PackV	Pack Voltage
2	Im	Current(Positive number when charging, negative when discharging, 0A when no operation)
3	XX	Actual value

c) Steps for viewing product Temperature information.

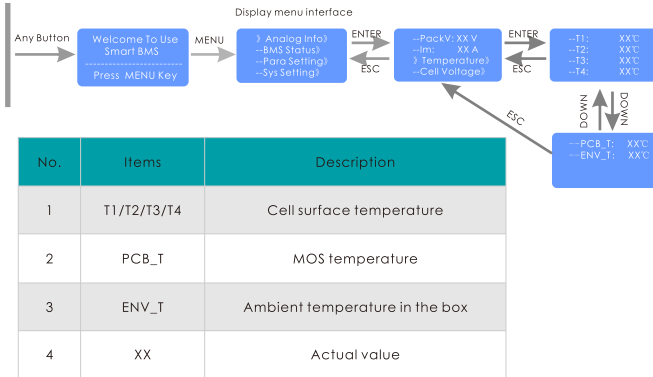

d) Steps for viewing product Cell Voltage information.

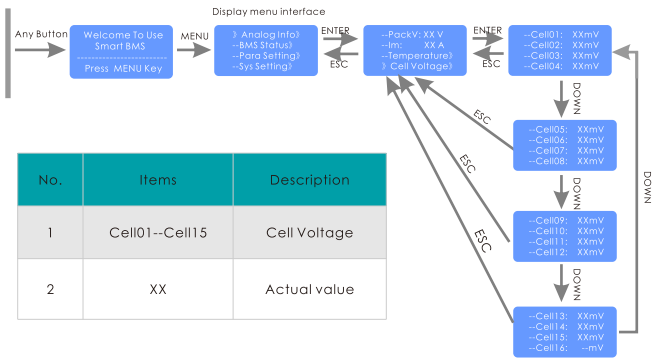

e) Steps for viewing product Cell Capacity information.

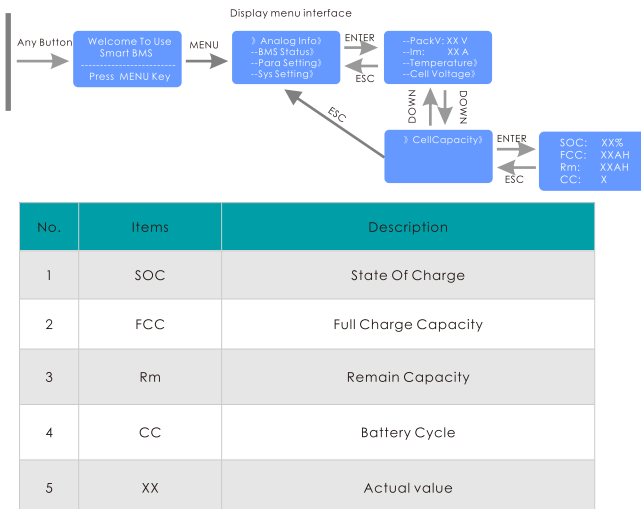

f) Steps to view product BMS protection times information

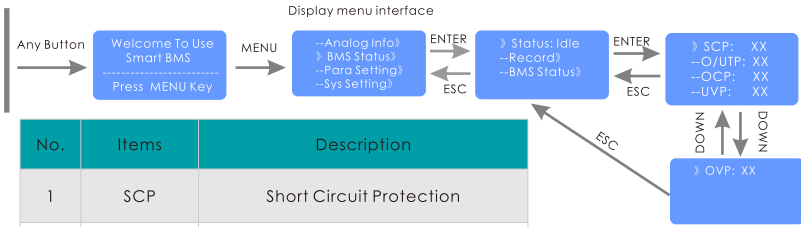

No.	Items	Description
1	SCP	Short Circuit Protection
2	O/UTP	Over/Up Temperature Protection
3	OCP	Over Current Protection
4	UVP	Up Voltage Protection
5	OVP	Over Voltage Protection
6	XX	Actual value

g) Steps to view product BMS real-time protection status information

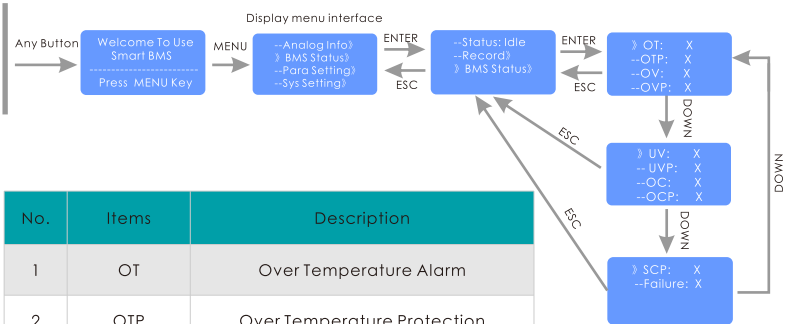

No.	Items	Description
1	OT	Over Temperature Alarm
2	OTP	Over Temperature Protection
3	OV	Over Voltage Alarm
4	OVP	Over Voltage Protection
5	UV	UP Voltage Alarm
6	UVP	UP Voltage Protection
7	OC	Over Current Alarm
8	OCP	Over Current Protection
9	SCP	Short Circuit Protection
10	Failure	BMS Failure
11	X	Y--Yes N--None

4.2.2 Indicator Description

a) There are 6 LEDs on front panel to show the battery working status:

PACK Status	Normal/Alarm/Protection	RUN	ALM	SOC Indication LEDs				Remark
Power Off	Sleep							All Off
Standby	Normal	Flash 1		Indication by SOC				Standby state
	Alarm	Flash 1	Flash 3					Cell low voltage
Charge	Normal			Indication by SOC (The top SOC LED flash2)				ALM LED is OFF When Cell Over-Charge or PACK Over-charge Alarm
	Alarm		Flash 3					
	Over Charge Protection							If no mains supply, LED as standby
	Temperature Protection; Over-Current Protection; Short Circuit Protection; Fault Protection							Close Charge
Discharge	Normal	Flash 3		Indication by SOC				
	Alarm	Flash 1	Flash 3					
	Under Discharge Protection							Close Discharge
	Temperature Protection; Over-Current Protection; Short Circuit Protection; Fault Protection							Close Discharge
Fault								Close Charge; Close Discharge

b) LED Capacity Indicators Status Description:

Status	Charge				Discharge				
Capacity Indication	L4	L3	L2	L1	L4	L3	L2	L1	
SOC (%)	0~25%				Flash2				
	25-50%			Flash2					
	50-75%		Flash2						
	75-100%	Flash2							
RUN Indication					Flash3				

c) LED Indicators Flash Description:

Flash Mode	ON	OFF
Flash1	0.25S	3.75S
Flash2	0.5S	0.5S
Flash3	0.5S	1.5S

4. 2.3 Buzzer Operation

Mode	Status Description
Fault	Buzzing 0.25S per 1S
Protection	Buzzing 0.25S per 2S(Except for Over-Voltage Protection)
Alarm	Buzzing 0.25S per 3S(Except for Over-Voltage Alarm)

NOTICE

The buzzer function can be turned on or off through the software, and the default is turned off.

4. 2.4 RST Button Operation

Mode	Operation Method
Activation	When BMS is sleeping, press the "RST" button for 3~6S, BMS is activation when the LED lights flicker from "RUN" light to the lowest capacity indicator
Sleep	When BMS is activation, press the "RST" button for 3~6S, BMS is sleep when the LED lights flicker from the lowest capacity indicator to "RUN" light
Reset	When BMS is activation, press the "RST" button for 6~10S, BMS is reset when the LED indicators all light up at the same time

NOTICE

When "BMS" need to sleep and activate, the "RST" button can be use.

NOTICE

When the "BMS" shows that the data measurement is inaccurate, the "RST" button can be used. In this case only qualified and trained electrical technicians are allowed to operate the value modifications. Operation personnel should understand the composition and working principles of the battery system.

4. 2.5 Sleep&Activation Operation

The battery cell or PACK enters the sleep mode after over-discharge protection, and wakes up every 4 hours at regular intervals to turn on the charge and discharge MOS. If it can be charged, it will exit the sleep state and enter normal charging; if it cannot be charged after 10 consecutive automatic wake up, it will not wake up automatically.

When the BMS is defined as the end of charging, after 2 days of standby (standby time set value), the recovery voltage is not reached, and the charging is forced to resume until the end of the recharge.

Mode	Status	Remark
Sleep	Cell or PACK over-discharge protection is not released within 60S	Before entering sleep, make sure that the input is not connected to an external voltage, otherwise you will not be able to enter sleep mode
	When BMS is activation, press the "RST" button for 3~6S	
	The lowest cell voltage is lower than the sleep voltage, and the duration reaches the sleep delay time (no communication, no protection, no balance, no current)	
	Standby time is greater than 24 hours (no communication, no charge and discharge, no mains)	
	Forced sleep through software	
Activation	Connect the charger, the charger output voltage is greater than 48V	When the BMS is in sleep mode
	When BMS is Sleep, press the "RST" button for 3~6S	
	Communication activation (RS232/RS485)	

4. 2.6 Battery Monitoring

The cable connects the battery to the computer, and the battery can be monitored through software.

a) Software Running Environment

The software running on the PC and its compatible computer, using the WINDOWS operating system. System environment requires Microsoft.net Framework version 2.0 or above Framework support, please make sure you have installed well before use, installation is as follows:

Step 1: Download Microsoft version of Microsoft.net Framework.



Step 2: Double-click the downloaded program to install (different versions of the installation steps, but follow the Microsoft instructions).



Step 3: The software does not need to be installed independently, only the environment content, double-click the exe file to run,The runtime displays the software's main interface.

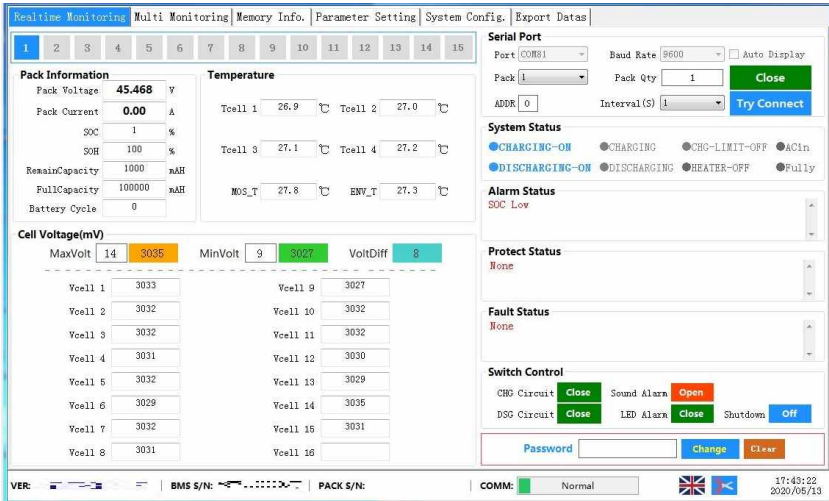
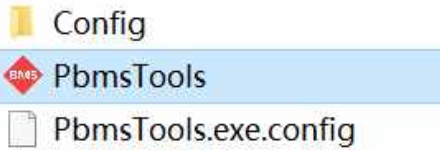

25

Step 4: After open the main interface , the software will automatically search all the existing serial port,if found effective serial port, and will automatically connect the serial port communication, real-time read battery information, temperature, monomer voltage, the system state and alarm status, such as protection, fault state battery parameters. If an effective serial port is not found, it will be prompted to open the serial port and start the monitoring manually,Unsuccessful search for serial prompt .

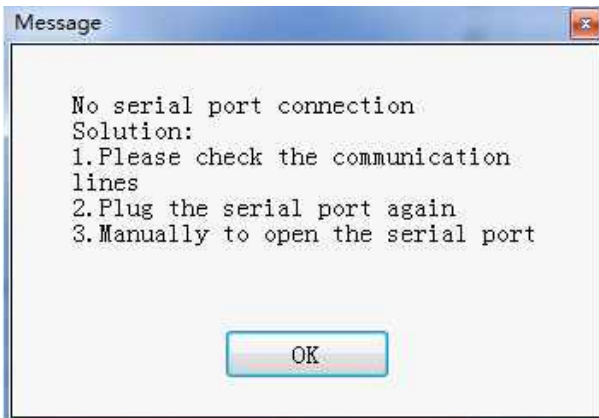

b) Install USB Turn Interface Drive

Step 1 : Double click the SETUP button to enter the installation interface.

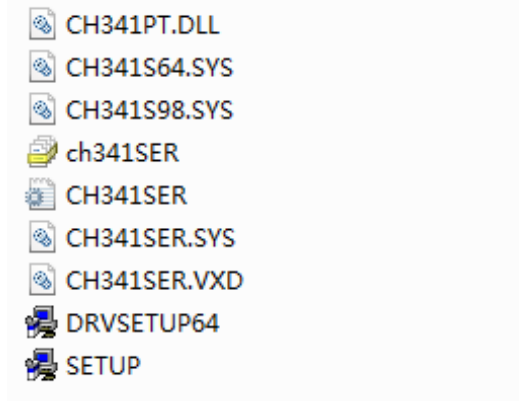

Step 2 : Double click the SETUP button to enter the installation interface.

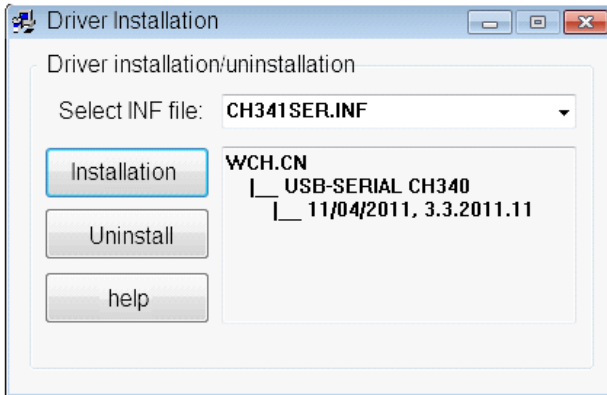

Step 3 : Click the install button, and install it, wait until finished the installation.

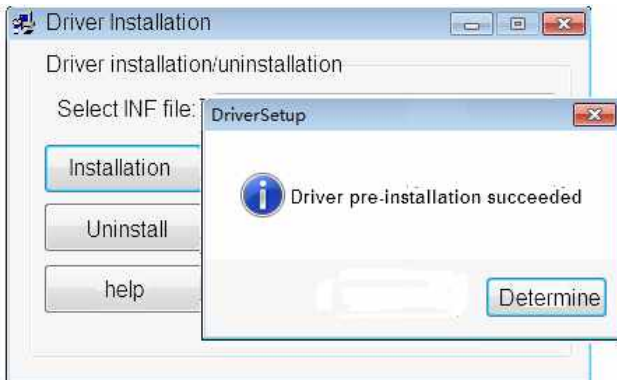

Step 4: Insert the communication converter USB line, then turn on the computer management device to check if there is a display USB turn interface driver, the device name of communication converter is CH340, indicate that the driver is installed successfully, and remember the corresponding serial port number COMx. It will be used below:

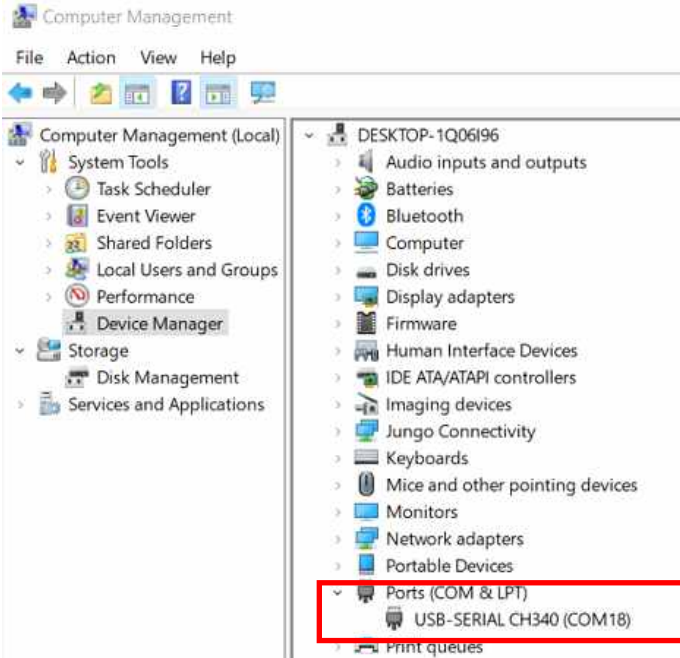

27

c) Realtime Monitoring Function UI.

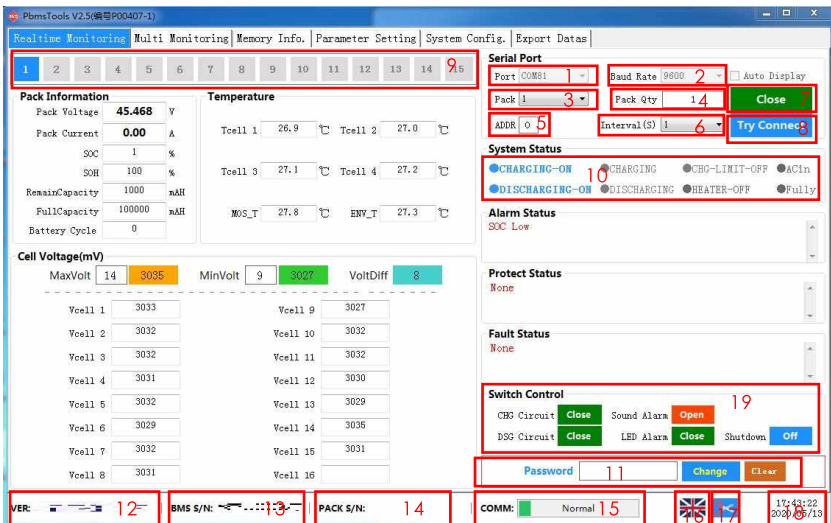

No.	Main control instructions	Remark
1	Port	Select the drop-down option and select the serial port to communicate. Available when the serial port is not opened
2	Baud Rate	Optional drop down, choosing the baud rate for communication. Available when the serial port is not opened
3	Pack	You can select the drop-down item, the current read Pack, and the RS232 interface to the host when you select FF, and you can get all the Pack data. Available when monitoring is not started
4	Pack Qty	Read-only values, the number of Pack packs that were read from the BMS board when applied to multi-machine parallel, from the main Pack to the Pack data
5	ADDR	A read-only value, the current read BMS address values
6	Interval(s)	Optional items. This PC to read data from the BMS samples of time interval
7	Open/Close	Alternate function button, open or close serial port
8	Start Monitor	Alternate function button, start or stop the monitoring, monitoring time and frequency of data read is 6 set time interval
9	Group Packs	The data key, which is the pack serial number, displays the pack that the current interface is reading and rendering with the blue bottom white. The "auto" button, alternate function button. When the three pack selects the FF and starts the monitoring, the automatic loop displays the various pack data (applied in parallel for multiple machines)
10	System Status	When a system state occurs, the text is blue. Gray means not happening
11	Administrator password bar	Some Settings are required for the administrator password to be used, such as some functionality in system Settings. (note: when the password is correctly entered, the input box will be green, and you have access to the administrator)
12	Versions	BMS software version number
13	BMS S/N	Barcodes for BMS boards
14	PACK S/N	Barcodes for PACK
15	COMM State	This software with BMS board status of communication. For effective when started monitoring and communication is normal.
16	Change Language	Display the national flag icon of the current language country, click to switch the language
17	Screenshot	Click to enter the screenshot state, and after you draw the screenshot area with the mouse, a toolbar will appear, and you can copy/save the screenshot
18	Time	PC time
19	Switch Control	When the button is red, it means the function processing is off, and when it is green, it means it is on

NOTICE

More information about battery protection settings, data downloading please read the Upper Computer Software Manual, Only qualified and trained electrical technicians are allowed to operate the value modifications, Operation personnel should understand the composition and working principles of the battery system.

5. CARE AND MAINTENANCE

5.1 Care

Before storing, make sure that the battery SOC is 50%-60%. Insulate it and store it in a cool and dry place. The recommended long-term storage temperature is 20°C -30°C. During storage, please charge the battery according to the following table:

Storage Temperature	Recharge Frequency	SOC
20°C~30°C	Every 6 Months	50%~60%

5.2 Maintenance

NOTICE

When replace the battery, install the same number and same type of battery.

WARNING

The battery system operates with hazardous voltages. Repairs must be carried out only by qualified maintenance personnel.

CAUTION

Even after the unit is disconnected from the power supply, the internal components are still connected to the battery cells, which is potentially dangerous.

CAUTION

Before carrying out any kind of service and/or maintenance, disconnect the batteries and make sure that no current and hazardous voltage exists in the terminals.

CAUTION

Only those who are fully familiar with battery and have the required precaution may replace the battery and supervise operations. Unauthorized personnel are strictly prohibited to disassemble the battery.

CAUTION

Verify that there is no voltage between the battery terminals and the ground before maintenance or repair. In this product, the battery circuit is not isolated from the input voltage. Hazardous voltages may occur between the battery terminals and the ground.

CAUTION

Battery may cause electric shock and have a high short-circuit current. Please remove all wristwatches, rings and other metal personal objects before maintenance or repair, and only use tools with insulated grips and handles for maintaining or repairing.

6. FAQ AND TROUBLESHOOTING

6.1 FAQ

Question 1: Why the charge current is only 20A or 0.5C?

Solution: The charge current depends on:

- The power of your charge devices;
- The settings of charge current limit module in battery pack;
- Charging communication data from the battery to the inverter.

When the inverter is connected to the battery in the user-defined mode and the charging current given by the inverter is more than 1C (default value), the battery's charging current module will work to limit the charging current to 20A to better maintain the battery.

Question 2: Can I set the value that triggers the Charge Current Limit Module to turn on?

Solution: You can set the value on battery software for PC. The max. setting value is 100A.

NOTE

For better battery maintenance, we do not recommend setting the charging current to exceed 0.2C.

30

Question 3: How many batteries do I need to configure my inverter?

Solution: It depends on:

- Your daily backup power requirements;
- The battery DOD;
- The output power of your inverter.

We suggest the configuration as below:

Off grid / hybrid Inverter output power	3kw~5kw	5kw~6kw	6kw~8kw	8kw~12kw	12kw~15kw	15kw~20kw
Battery Model And Min Parallel QTY.	iPower 48V100Ah 4.8kWh * 1	iPower 48V100Ah 4.8kWh * 2	iPower 48V100Ah 4.8kWh * 2	iPower 48V100Ah 4.8kWh * 3	iPower 48V100Ah 4.8kWh * 4	iPower 48V100Ah 4.8kWh * 5

NOTICE

Before choosing the number of batteries you need, you need to consider your daily backup time requirements and the power match between the battery and the inverter, battery output power parameters shall be greater than inverter's.

Question 4: Why the monitoring software show abnormal?

Solution: After connect the battery with computer by RJ11-USB cable. You need to download the USB driver to make sure the computer access to the battery data.

Question 5: Why not throw away used batteries at will?

Solution: After the used battery is abandoned, the outer casing of the battery will slowly corrode, and the metal substances in it will gradually penetrate into the water and soil, causing pollution. The biggest feature of metal pollution is that it cannot be degraded in nature and can only be eliminated through purification. On the other hand, the effective recovery of metals and the utilization of surplus energy can also bring considerable economic benefits.

6.2 Troubleshooting

Analysis and treatment of common faults.

Fault Phenomenon	Reason Analysis	Solution
The battery cannot be turned on	System protection	Battery cannot turn on, switch on the lights are all no lighting or flashing.If the battery external switch is ON, the RUN light is flashing, and the external power supply voltage is 48V or more, the battery still unable to turn on, please contact manufacturer
Red light is lighting, and cannot charge or discharge	System protection	Change power parameters; Charge the battery immediately(When over discharge protection)
DC power supply time is too short	Battery capacity become smaller	Storage battery replacement
The power line sparks once power on and ALM light RED	Power connection short-circuit	Turn off the battery, check the cause of the short circuit
Abnormal communication	PC cannot read device information	Whether the device is turned on; Is the PC software used correctly; Whether the PC software correctly reads the serial port; Signal line wiring and address are correct.



Enjoy the sunkiss
Enjoy iPower

